

GP Batteries

Data Sheet

Model No.: GP623048L85

Type	: Rechargeable Lithium Ion Prismatic Cell
Nominal Dimension (without Label)	: Width = max. 30.0mm Height = max. 48.0mm Thickness (shipment) = 6.7mm * Thickness (cycled) = 6.8mm **
Nominal Voltage	: 3.7V
Capacity	: Typical: 850mAh (at 20°C) Minimum: 820mAh
Standard Charge	: 510mA to 4.2V for 2.5hrs at 20°C
Maximum Charging Voltage	: 4.20V
Standard Discharge	: 170 to 850mA to 2.8V
Service Life	: 300 cycles (70% of initial capacity)
Weight	: Approx. 21g
Internal Resistance	: 120mΩ max. at 1000Hz
Ambient Temperature Range	: Charging : 0 to 45°C Discharging : -30 to 60°C Storage : -30 to 45°C

Note: * The "Thickness (shipment)" is the maximum value without tube of the standard shipment charging condition (30% state of charge).
** The "Thickness (cycled)" is the maximum value without tube after cycling for 300 cycles and is for reference only.

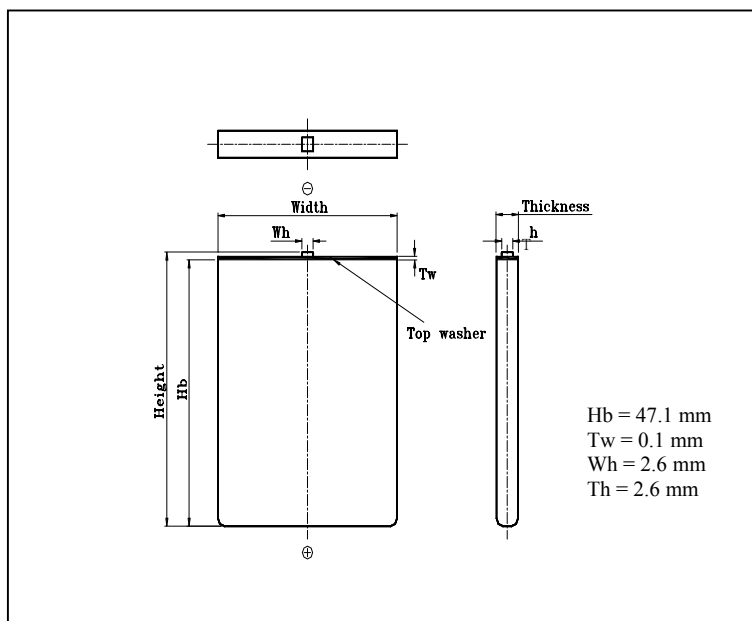

Charging Characteristics

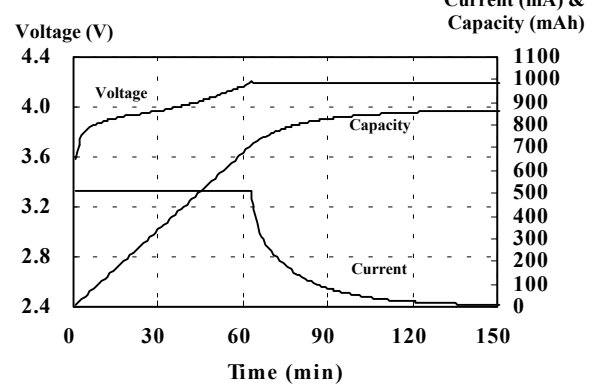

Discharging Characteristics

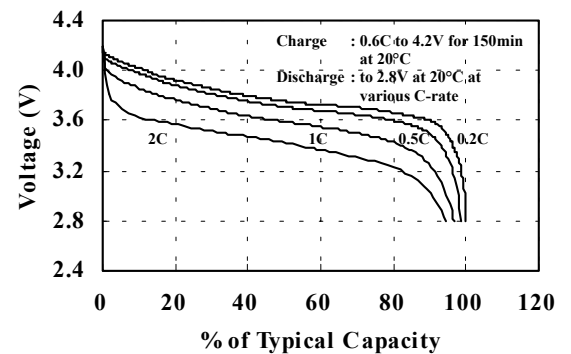

Discharge Temperature Characteristics

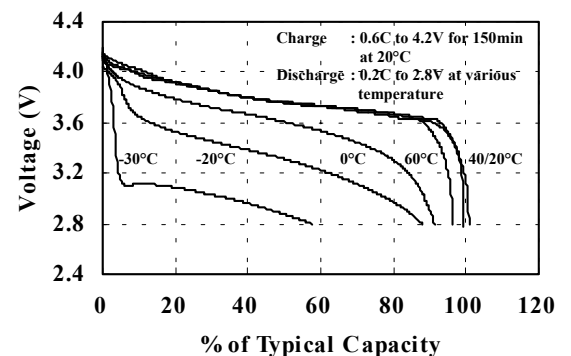

* The information (subject to change without prior notice) contained in this document is for reference only and should not be used as a basis for product guarantee or warranty. For applications other than those described here, please consult your nearest GP Sales and Marketing Office or Distributors.