

GP Batteries

Data Sheet

Model No.: GP20R7H

Type	Rechargeable Nickel Metal Hydride Cylindrical Cell	
Nominal Dimension (with Sleeve)	15.7 mm(l) x 26.5 mm(w) x 48.5 mm(h)	
Applications	Recommended discharge current 20 to 600 mA	
Nominal Voltage	7.2V	
Capacity	Minimum: 200 mAh Typical: 210 mAh when discharged at 0.2C to 1.0V at 20°C	
Charging Condition	20 mA for 16 hrs at 20°C	
Fast Charge	100 mA to 200 mA (0.5 to 1C) charge termination control recommended control parameters: -ΔV : 0 - 30mV DT/dt ** : 0.8°C/min (0.5 to 0.9C) : 0.8 - 1°C/min (1C) TCO ** : 45 - 50°C Timer **: 105% nominal input ** For reference only	
Service Life	>500 cycles (IEC standard) Up to 1000 cycle (noy less than 60% of Nominal at 0.1C charge / 0.2c Discharge)	
Continuous Overcharge	20 mA maximum current for 1 year No conspicuous deformation and/or leakage	
Weight	36.5 g	
Internal Resistance	Maximum 1200 mΩ upon fully charged at 1000HZ	
Max. Charging Voltage	9V at 20mA charging	
Ambient Temperature Range	Standard Charging	0 to 45°C
	Fast Charging	10 to 45°C
	Discharging	-20 to 50°C
	Storage	-20 to 35°C

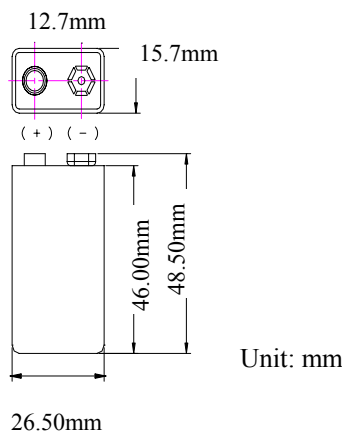

Fast Charge (charge control required)

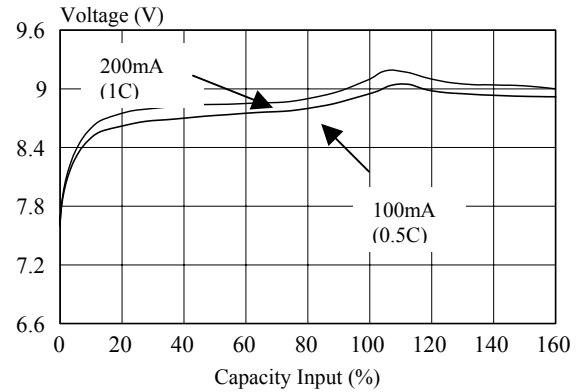

Low Rate Discharge

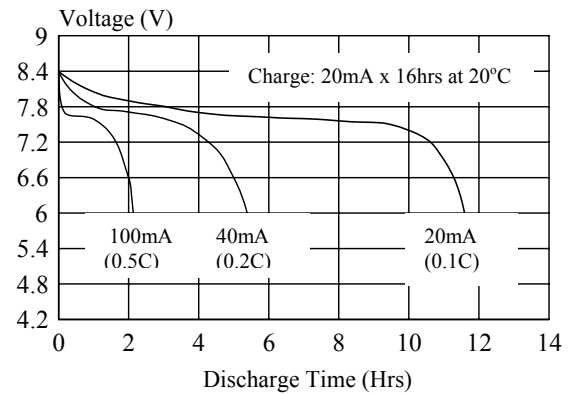

High Rate Discharge

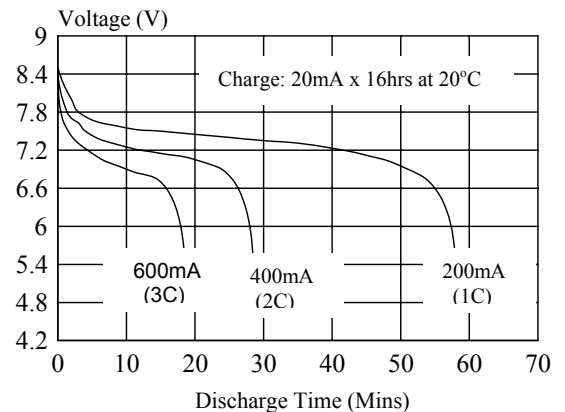

* The information (subject to change without prior notice) contained in this document is for reference only and should not be used as a basis for product guarantee or warranty. For applications other than those described here, please consult your nearest GP Sales and Marketing Office or Distributors.